

TRANSISTOR (PNP)

FEATURES

- High Breakdown Voltage

MARKING:4D

MAXIMUM RATINGS ($T_a=25^\circ\text{C}$ unless otherwise noted)

Symbol	Parameter	Value	Unit
V_{CBO}	Collector-Base Voltage	-400	V
V_{CEO}	Collector-Emitter Voltage	-400	V
V_{EBO}	Emitter-Base Voltage	-5	V
I_C	Collector Current -Continuous	-200	mA
I_{CM}	Collector Current -Pulsed	-300	mA
P_C	Collector Power Dissipation	350	mW
$R_{\theta JA}$	Thermal Resistance From Junction To Ambient	357	$^\circ\text{C}/\text{W}$
T_j	Junction Temperature	150	$^\circ\text{C}$
T_{stg}	Storage Temperature	-55~+150	$^\circ\text{C}$

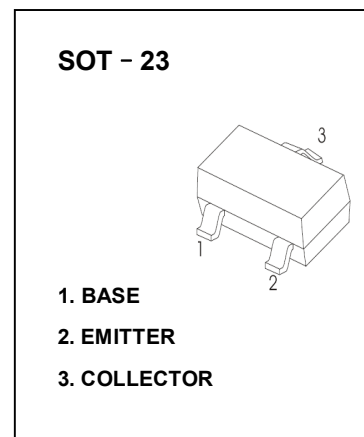

ELECTRICAL CHARACTERISTICS ($T_a=25^\circ\text{C}$ unless otherwise specified)

Parameter	Symbol	Test conditions	Min	Typ	Max	Unit
Collector-base breakdown voltage	$V_{(BR)CBO}$	$I_C=-100\mu\text{A}, I_E=0$	-400			V
Collector-emitter breakdown voltage	$V_{(BR)CEO}$	$I_C=-1\text{mA}, I_B=0$	-400			V
Emitter-base breakdown voltage	$V_{(BR)EBO}$	$I_E=-100\mu\text{A}, I_C=0$	-5			V
Collector cut-off current	I_{CBO}	$V_{CB}=-400\text{V}, I_E=0$			-0.1	μA
Collector cut-off current	I_{CEO}	$V_{CE}=-400\text{V}, I_B=0$			-5	μA
Emitter cut-off current	I_{EBO}	$V_{EB}=-4\text{V}, I_C=0$			-0.1	μA
DC current gain	$h_{FE(1)}$	$V_{CE}=-10\text{V}, I_C=-10\text{mA}$	80		300	
	$h_{FE(2)}$	$V_{CE}=-10\text{V}, I_C=-1\text{mA}$	70			
	$h_{FE(3)}$	$V_{CE}=-10\text{V}, I_C=-100\text{mA}$	40			
	$h_{FE(4)}$	$V_{CE}=-10\text{V}, I_C=-50\text{mA}$	40			
Collector-emitter saturation voltage	$V_{CE(sat)1}$	$I_C=-10\text{mA}, I_B=-1\text{mA}$			-0.2	V
	$V_{CE(sat)2}$	$I_C=-50\text{mA}, I_B=-5\text{mA}$			-0.3	V
Base-emitter saturation voltage	$V_{BE(sat)}$	$I_C=-10\text{mA}, I_B=-1\text{mA}$			-0.75	V
Transition frequency	f_T	$V_{CE}=-20\text{V}, I_C=-10\text{mA}, f=30\text{MHz}$	50			MHz

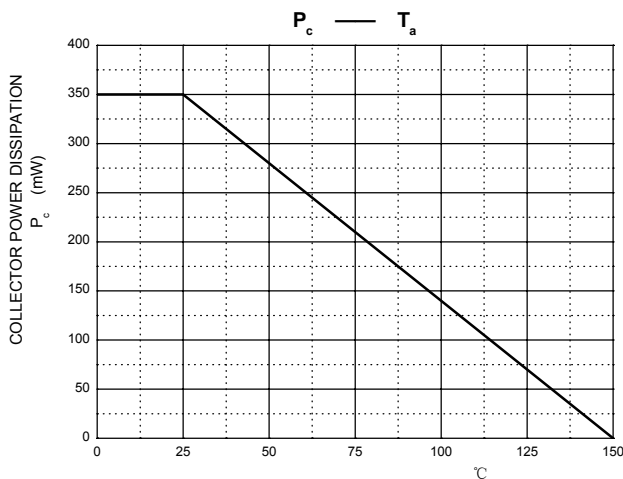
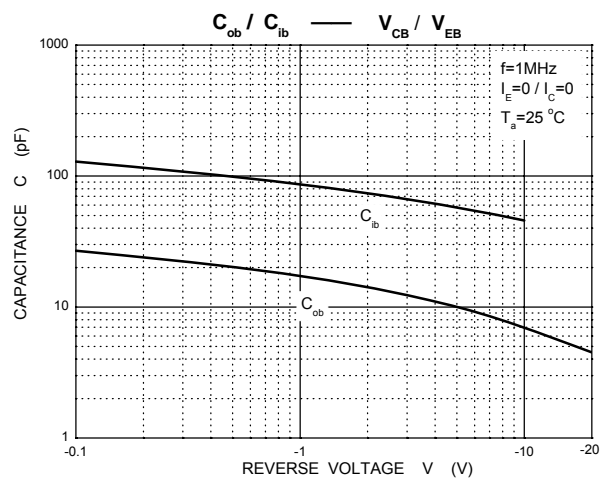
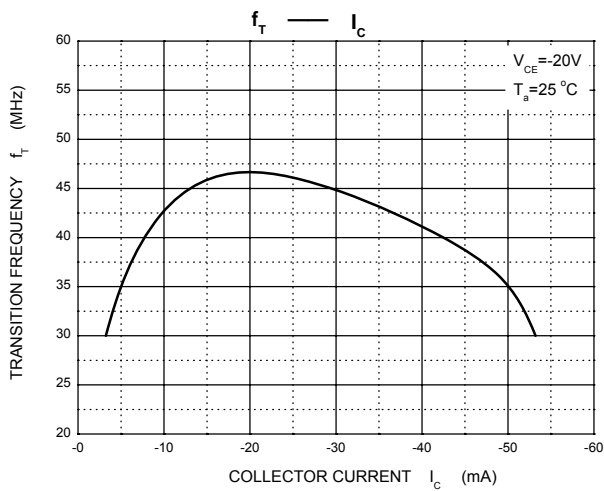
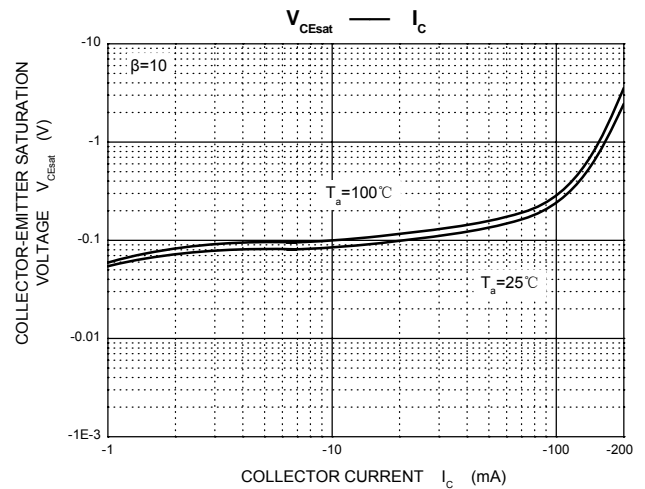
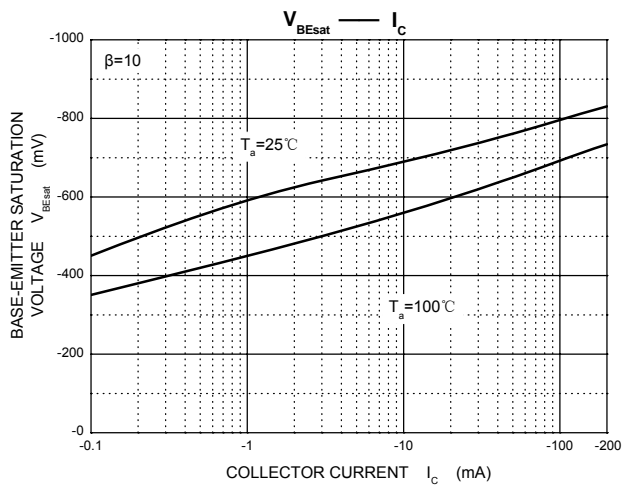
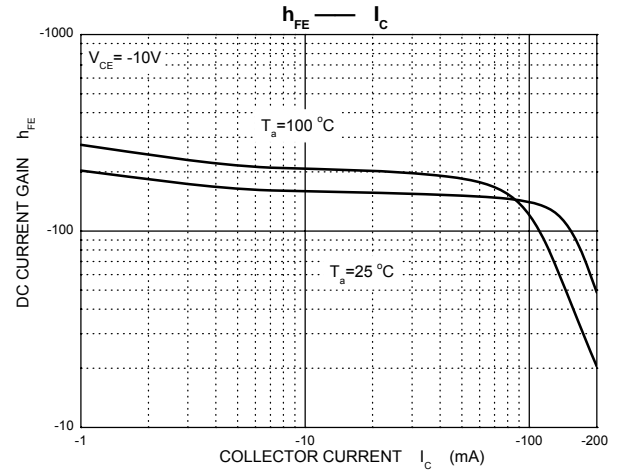
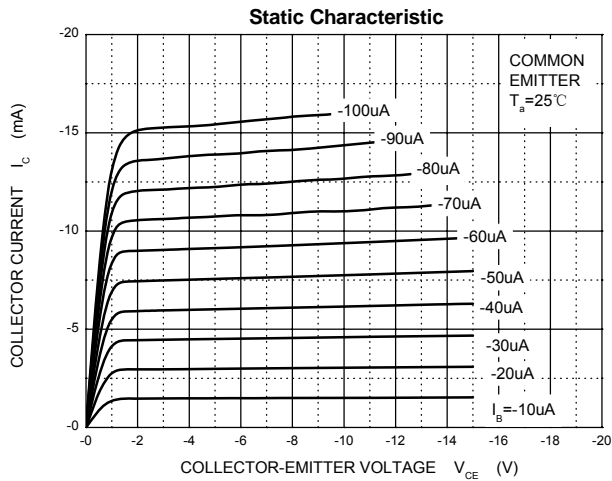

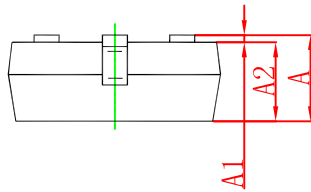
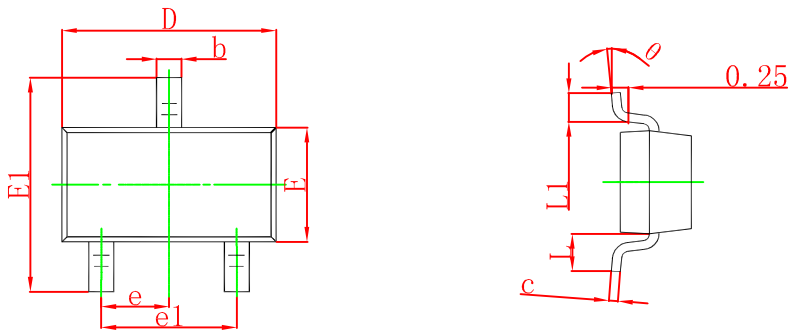

Symbol	Dimensions In Millimeters		Dimensions In Inches	
	Min	Max	Min	Max
A	0.900	1.150	0.035	0.045
A1	0.000	0.100	0.000	0.004
A2	0.900	1.050	0.035	0.041
b	0.300	0.500	0.012	0.020
c	0.080	0.150	0.003	0.006
D	2.800	3.000	0.110	0.118
E	1.200	1.400	0.047	0.055
E1	2.250	2.550	0.089	0.100
e	0.950 TYP		0.037 TYP	
e1	1.800	2.000	0.071	0.079
L	0.550 REF		0.022 REF	
L1	0.300	0.500	0.012	0.020
θ	0°	8°	0°	8°

SOT-23 Suggested Pad Layout

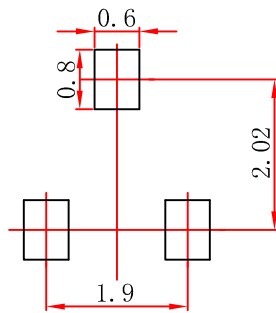

- Note:
1. Controlling dimension: in millimeters.
 2. General tolerance: ± 0.05 mm.
 3. The pad layout is for reference purposes only.